

ET16

Tracked Conventional Tail Excavators



**WACKER
NEUSON**
all it takes!



Best in class in terms of cabin size

In addition to its comfortable cabin, the ET16 also impresses with a compact and sturdy design. With a shipping weight of less than 1.6 tons, it can be quickly and easily transported from one construction site to the next. It is the ideal companion for any application due to a simple and safe operation.

- Full power for faster work cycles
- Comfort cabin for the highest demands
- Easy transportation
- Telescoping travel gear and powerful additional hydraulics
- Unrestricted service and maintenance access

ET16 Technical specifications

Operating data

Shipping weight min.	1,402 kg
Operating weight	1,529 - 1,720 kg
Biting force max.	7.9 kN
Breakout force max.	15.3 kN
Digging depth max.	2,413 mm
Dumping height	2,371 - 2,518 mm
Digging radius max.	3,861 mm
Superstructure slewing speed	9.8 1/min
L x W x H	3,644 x 990 x 2,285 mm

Engine / Motor

Engine / Motor manufacturer	Yanmar
Engine / Motor type	3TNV76
Engine / Motor	Liquid-cooled, 3-cylinder diesel engine
Displacement	1,116 cm ³
RPM / speed	2,200 rpm
Engine performance according to ISO	13.8 kW
Battery	44 Ah
Fuel tank capacity	24 l

Hydraulic system

Duty pump	Gear pump
Flow rate	34.5 l/min
Operating pressure for working and driving hydraulics	200 bar
Operating pressure Slewing gear	130 bar
Hydraulic oil tank	20 l

Undercarriage

Travel speed	4.1 km/h
Chain width	230 mm
Ground clearance	180 mm

Dozer Blade

Width Folded-over	990 mm
Height	215 mm
Stroke max. above subgrade	235 mm
Stroke max. below subgrade	270 mm

Sound level

Sound level (LwA) according to 2000/14/EC	93 dB(A)
Cabin - specified sound pressure level LpA	79 dB(A)

ET16 Dimensions

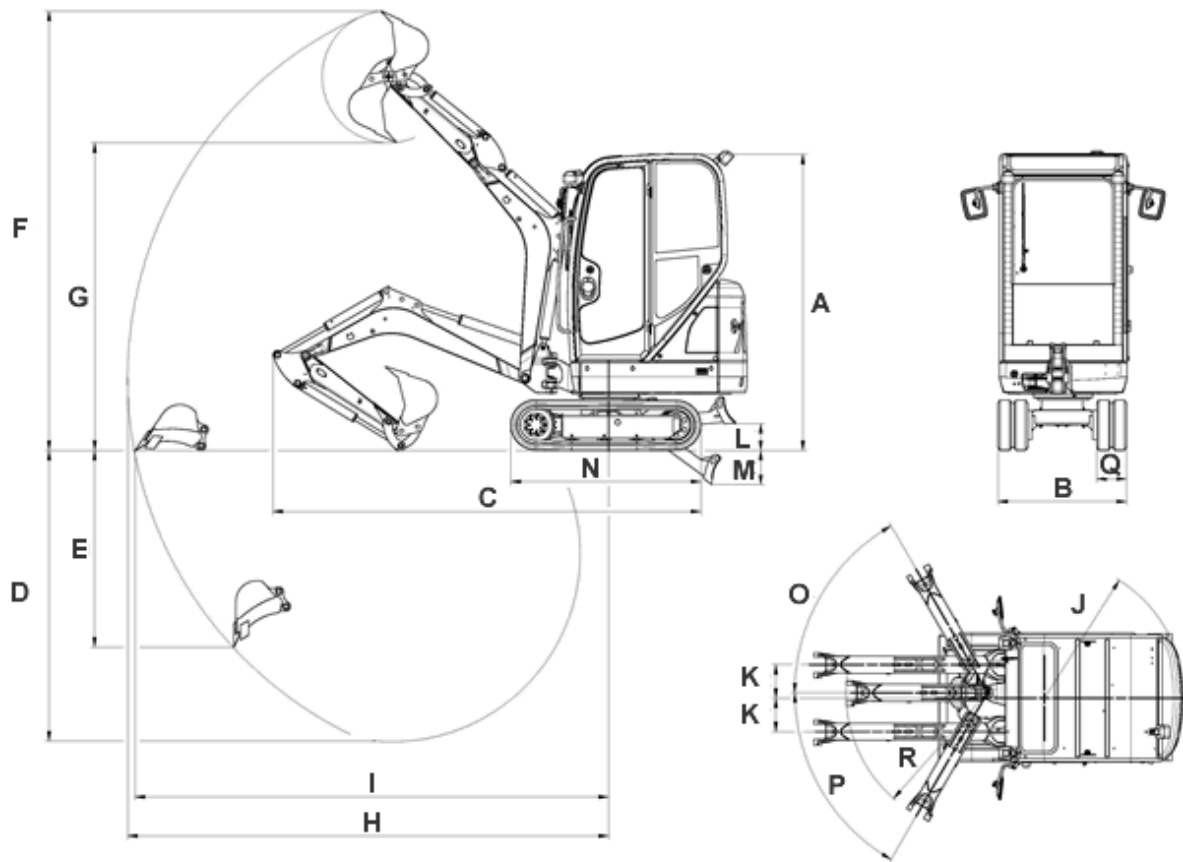

		Standard travel gear	Telescopic travel gear
A	Height	2,285 mm	2,317 mm
B	Width Track width	990 mm	990 mm
B	Width Track width extended		1,300 mm
C	Transport length Short dipper stick	3,644 mm	3,648 mm
C	Transport length Long dipper stick	3,607 mm	3,606 mm
D	Digging depth max. Short dipper stick	2,242 mm	2,202 mm
D	Digging depth max. Long dipper stick	2,413 mm	2,372 mm
E	Insertion depth Short dipper stick	1,642 mm	1,605 mm
E	Insertion depth Long dipper stick	1,802 mm	1,764 mm
F	Insertion height Short dipper stick	3,387 mm	3,408 mm
F	Insertion height Long dipper stick	3,508 mm	3,529 mm
G	Dump height max. Short dipper stick	2,371 mm	2,396 mm
G	Dump height max. Long dipper stick	2,493 mm	2,518 mm
H	Digging radius max. Short dipper stick	3,700 mm	3,700 mm
H	Digging radius max. Long dipper stick	3,861 mm	3,860 mm
I	Range Short dipper stick	3,648 mm	3,642 mm
I	Range Long dipper stick	3,811 mm	3,806 mm
J	Rear swivel radius	1,075 mm	1,075 mm

K	Arm displacement max. to center of bucket right side	432 mm	432 mm
K	Arm displacement max. to center of bucket left side	287 mm	287 mm
L	Lift height max. dozer blade above grade	211 mm	235 mm
M	Scraping depth max. dozer blade below grade	264 mm	270 mm
N	Length Travel gear	1,462 mm	1,462 mm
O	Turning angle max. (boom system to the right)	49 °	49 °
P	Turning angle max. (boom system to the left)	73 °	73 °
Q	Chain width	230 mm	230 mm
R	Boom slewing radius	1,195 mm	1,195 mm

Please note: that product availability can vary from country to country. It is possible that information / products may not be available in your country. More detailed information on engine power can be found in the operator's manual; the stated power may vary due to specific operating conditions. Subject to alterations and errors excepted. Applicable also to illustrations.
 Copyright © 2019 Wacker Neuson SE.